

深圳金亚太科技有限公司

Shenzhen Geniatech Co.,Ltd.

SPECIFICATION

MODEL: XPI-3568
V1.1

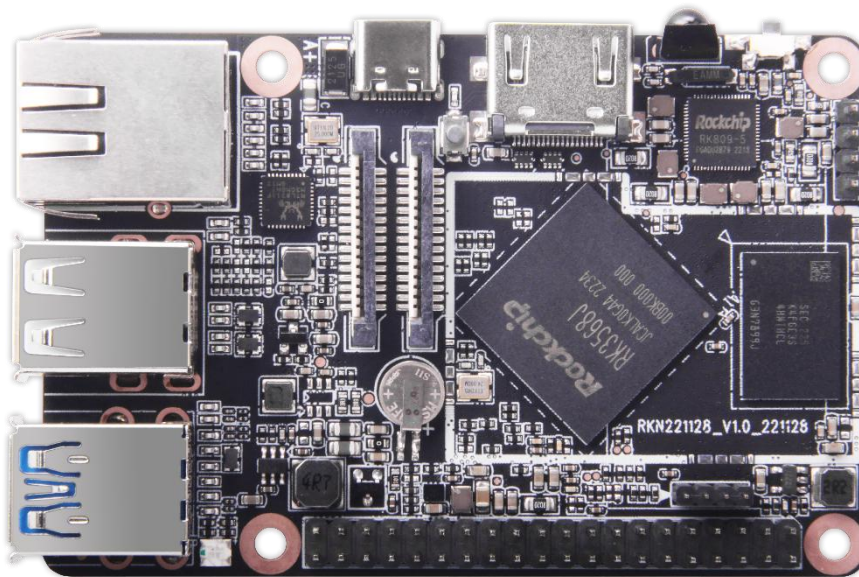

Confirmation

APPROVED BY GENIATECH		
PREPARED BY 编写	CHECKED BY 审核	APPROVED BY 批准

Please return the original copy after approved by your company with seal and signature.
请在贵公司盖章并签字后寄回正本一份。

APPROVED BY CUSTOMER		
COMMENTS 确认意见	APPROVED BY 批准签字	COMPANY SEAL 盖章

Website: www.geniatech.com

CONTENT

1. GENERAL DESCRIPTION	4
2. PRODUCT OVERVIEW	5
3. FEATURES	6
4. HARDWARE BLOCK	7
5. Connectors Definition	8
5.1 MIPI CSI Connector (J24).....	8
5.2 MIPI DSI Connector(J23).....	9
5.3 USB Connector for Wi-Fi(J26).....	10
5.4 40 Pin GPIO header (J22).....	10
5.5 Cortex Debug UART Connector (J25).....	12
6. SUPPORT FORMATS	12
7. PRECAUTIONS FOR USE	14

Revision History

VERSION	DATE	BOARD ID	PAGE	DESCRIPTION	AUTHOR
V1.0	20230213		14	Initial Version	

1. GENERAL DESCRIPTION

The XPI-3568 is a microcomputer product of Raspberry Pi form factor developed by Geniatech based on the RockChip 3568J platform. According to the definition of Raspberry Pi, this is suitable for the field of programming education for teenagers, robotics, Commercial display industry and media play box and so on..

This product's key features including a RockChip high-performance and low power quad-core application 64-bit quad-core processor, HDMI display supports up to 4KP60 resolutions, XPI-3568 supports almost full-format H.264/H.265 decoder by 4K@60fps, also support H.264/H.265 encoder by 1080p@60fps, high-quality JPEG encoder/decoder. Up to 8GB of RAM, dual-band 2.4/5.0 GHz wireless LAN, Bluetooth 4.0, Gigabit Ethernet, USB 3.0 and USB 2.0.

Below is the detailed specification

- (I) 85mm*56mm, Only the size of a bank card
- (II) RockChip RK3566/RK35668J with Quad-core Cortex-A55 up to 1.8GHz
- (III) Up to 8G RAM, 128GB eMMc flash
- (IV) USB HOST 3.0 * 1, USB Host 2.0*2, USB OTG 3.0*1, 1*HDMI Out, 1*Type-C, 1*UART for debug, 1* Extension GPIO interface
- (V) Support Android 11.0 or Linux (Debian 10/ Raspbian OS emulation)
- (VI) Wi-Fi and 1000M LAN interface
- (VII) Micro SD card (TF card: Max64G)
- (VIII) Provide open-source code and hardware schematics
- (IX) The product has a long-life cycle and can be supplied over 10 years

2. PRODUCT OVERVIEW

Below picture is for reference only, please prevail in kind.

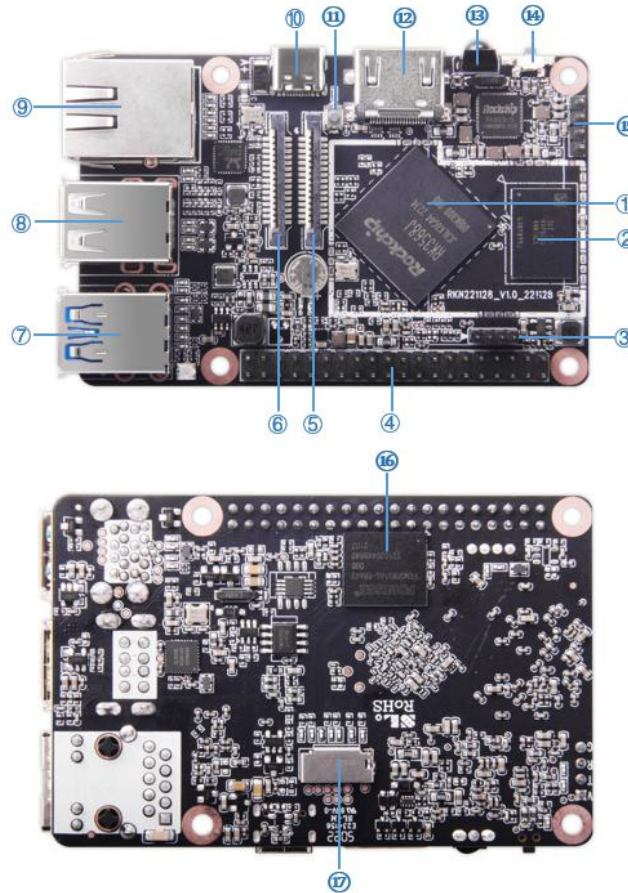

No.	Name	Description
1	RK3568J SOC	*1
2	LPDDR4	*1
3	USB Connector	*1(It can be used for Wi-Fi/BT port)
4	40 Pin GPIO header	*1
5	MIPI CSI Connector	*1
6	MIPI DSI Connector	*1
7	USB double layer connector	*1(The upper interface of J1 supports OTG function, the bottom interface of J1 supports USB 3.0 function)
8	USB2.0 double layer connector	*1
9	RJ45	*1(10/100/1000Mbps)
10	DC IN	*1(5V/3A USB Type-C)
11	SW1	*1(Power on key)
12	HDMI Connector	*1(up to 4KP60)

13	IR	*1
14	SW2	*1(Recovery Key)
15	A55 Core debug console	*1
16	eMMC Flash	*1
17	Micro SD card Slot	*1

3. FEATURES

CHIPSET	RK3568/RK3568J	
MARKET AREA	Global	
Processor	OS	Android 11/Debian 10/Raspbian OS emulation
	CPU	Quad-core ARM Cortex-A55 CPU up to 1.8GHz
	GPU	ARM G52 2EE GPU; Supports OpenGL ES 1.1/2.0/3.2. OpenCL 2.0. Vulkan 1.1 Embedded high-performance 2D acceleration hardware
	NPU	Integrated RKNN NPU AI accelerator, 1Tops@INT8 Supports one-click switching of Caffe/TensorFlow/TFLite/ONNX/PyTorch/Keras/Darknet
	LPDDR4	2GB (1G/4G/8G optional)
	EMMC FLASH	8GB eMMC5.1(8-128GB Optional)
NETWORK	Ethernet	RJ45, 10/100/1000M
	WiFi	WiFi Module 2.4G/5.8G (optional)
	Bluetooth	BT4.0(integrated in the WiFi module)
Interface	HDMI Out	*1
	USB 3.0	*2(USB Host 3.0*1, USB OTG 3.0*1)
	USB 2.0	*2(USB Host 2.0*2)
	MIPI-CSI	*1
	MIPI-DSI	*1
	Micro SD slot	*1
	IR	*1
DC IN	*1 (USB Type-C)	
Connectivity	1x Standard 40-pin GPIO header <ul style="list-style-type: none"> • Can be expanded to UART, SPI, I2C ,PWM function 1x4 pin USB-Wifi connector <ul style="list-style-type: none"> • Support USB-WiFi Module 1x MIPI DSI <ul style="list-style-type: none"> • 4-lane MIPI DSI display port 	

	1x MIPI CSI • 2-lane MIPI CSI camera port
Adapter	DC 5V / 3A
Dimensions	85*56mm

4. HARDWARE BLOCK

XPI-3568J Block Diagram

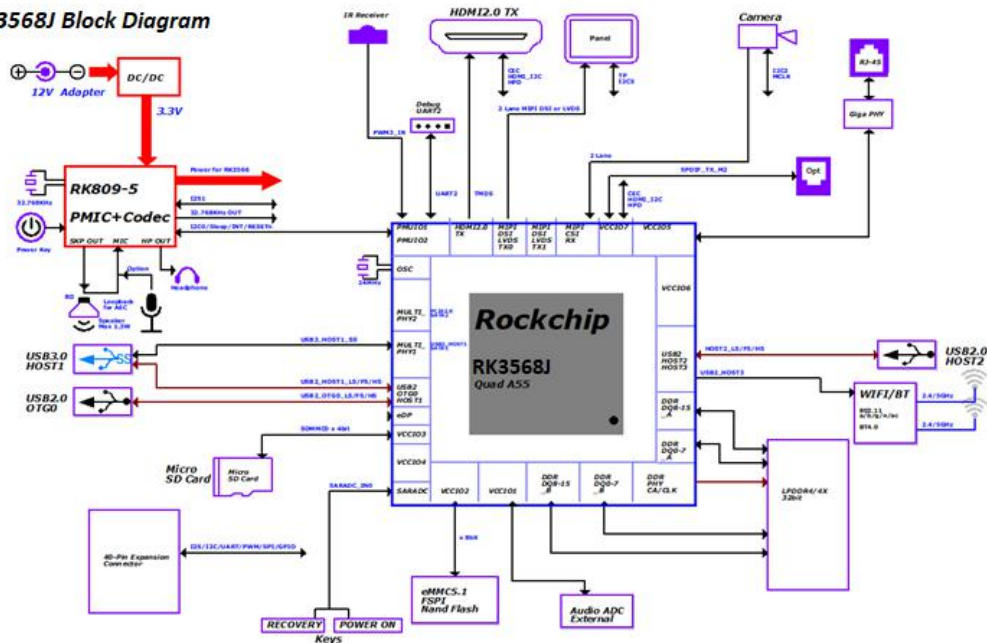

5. Connectors Definition

5.1 MIPI CSI Connector (J24)

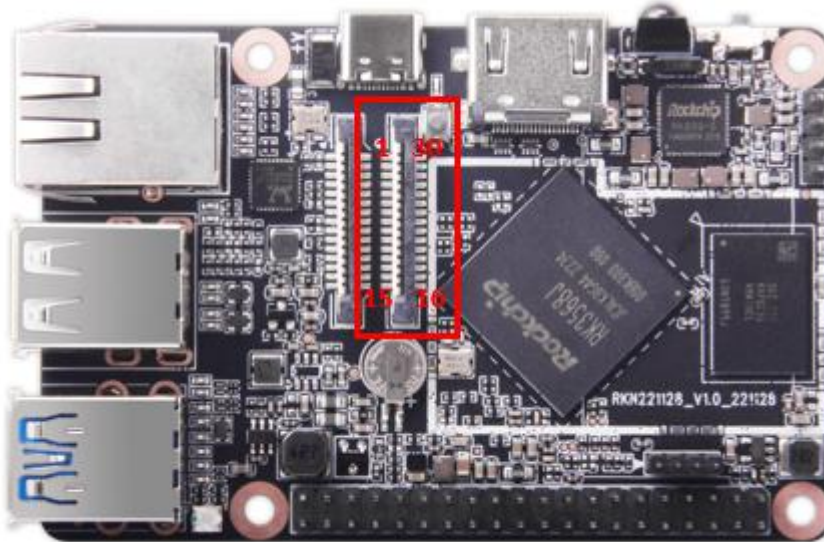

Pin	Definition	Pin	Definition
1	GND	9	MIPI_CSI_RX_CLKOP
2	MIPI_CSI_RX_D0N	10	GND
3	MIPI_CSI_RX_D0P	11	PCIE20 _ CLKREQn _ M
4	GND	12	NC
5	MIPI_CSI_RX_D1N	13	I2C1 _ SCK _ C
6	MIPI_CSI_RX_D1P	14	I2C1 _ SDA _ C
7	GND	15	VDDIO _ 3.3V
8	MIPI_CSI_RX_CLKON	16~30	NC

5.2 MIPI DSI Connector(J23)

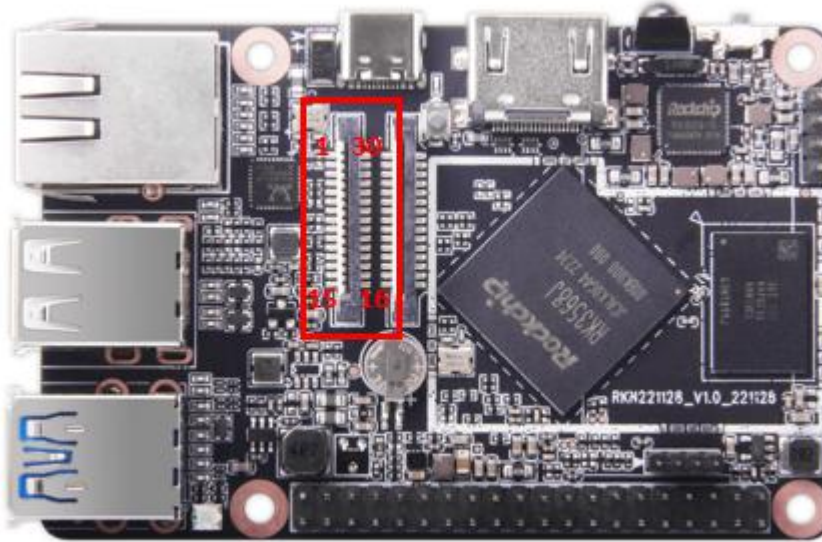

Pin	Definition	Pin	Definition
1	GND	30	NC
2	MIPI_TX0_D1N	29	MIPI_TX0_D2P
3	MIPI_TX0_D1P	28	MIPI_TX0_D2N
4	GND	27	NC
5	MIPI_TX0_CLKN	26	MIPI_TX0_D3P
6	MIPI_TX0_CLKP	25	MIPI_TX0_D3N
7	GND	24	NC
8	MIPI_TX0_D0N	23	NC
9	MIPI_TX0_D0P	22	SARADC_VIN2_LCD_I
10	GND	21	NC
11	I2C2_SCK_D	20	NC
12	I2C2_SDA_D	19	NC
13	GND	18	NC
14	VDDIO_3.3V	17	NC
15	VDDIO_3.3V	16	NC

5.3 USB Connector for Wi-Fi(J26)

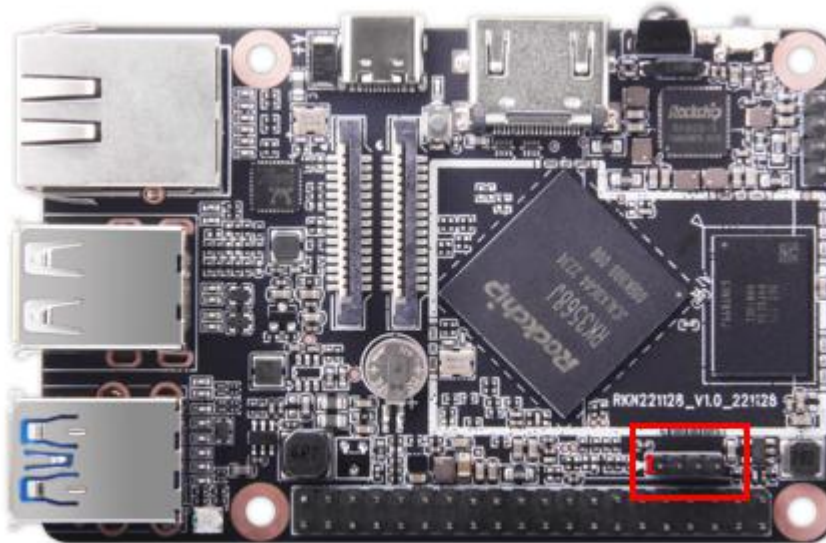

Pin	Definition	Pin	Definition
1	VCC5V0_USB	3	USB2_HOST2_DP
2	USB2_HOST2_DM	4	GND

5.4 40 Pin GPIO header (J22)

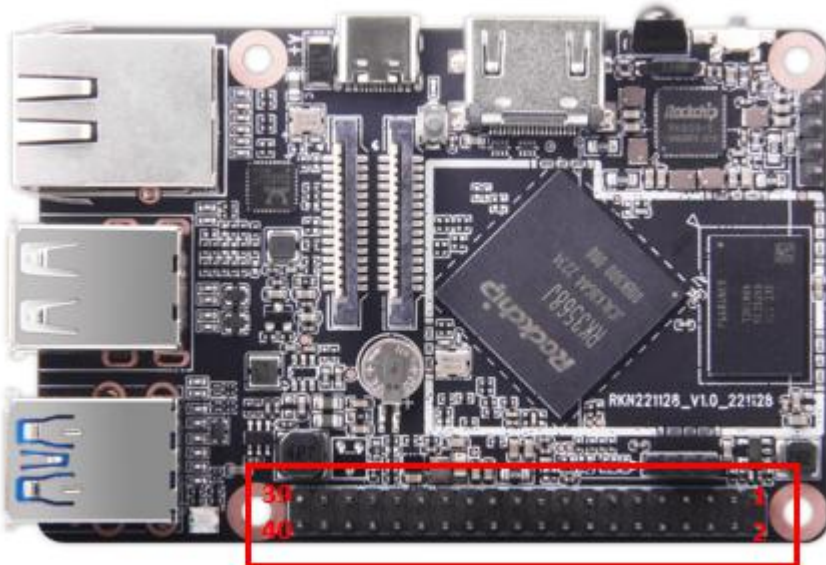

Pin	Definition	Pin	Definition
1	VDDIO_3.3V	2	VCC5V0_SYS
3	I2C5_SDA_M0/GPIO3_B3_D	4	VCC5V0_SYS
5	I2C5_SCL_M0/GPIO3_B4_D	6	GND
7	I2S1_MCLK_M1/GPIO3_C6_D	8	UART1_TX_M1/GPIO3_D6_D
9	GND	10	UART1_RX_M1/GPIO3_D7_D
11	SPI3_CLK_M0/GPIO4_B3_D	12	I2S1_SCLK_TX_M1/GPIO3_C7_D
13	SPI3_MOSI_M0/GPIO4_B2_D	14	GND
15	SPI3_MISO_M0/GPIO4_B0_D	16	UART1_CTSn_M1/GPIO4_C1_D
17	VDDIO_3.3V	18	UART1_RTSn_M1/GPIO4_B6_D
19	SPI2_MOSI_M1/GPIO2_D6_D	20	GND
21	SPI2_MISO_M1/GPIO2_D7_D	22	GPIO3_C4_PWM
23	SPI2_CLK_M1/GPIO3_A0_D	24	SPI2_CS0_M1/GPIO2_D5_D
25	GND	26	SPI2_CS1_M1/GPIO2_D4_D
27	I2C2_SDA_M1/GPIO4_B4_D	28	I2C2_SCL_M1/GPIO4_B5_D
29	SPI3_CS0_M0/GPIO4_A6_D	30	GND
31	SPI3_CS1_M0/GPIO4_A7_D	32	UART4_TX_M1_PWM/GPIO3_B2_D
33	UART4_RX_M1_PWM/GPIO3_B1_D	34	GND
35	I2S1_LRCK_TX_M1/GPIO3_D0_D	36	UART3_RX_M1/GPIO3_C0_D
37	UART3_TX_M1/GPIO3_B7_D	38	I2S1_SDI0_M1/GPIO3_D2_D
39	GND	40	I2S1_SDO0_M1/GPIO3_D1_D

5.5 Cortex Debug UART Connector (J25)

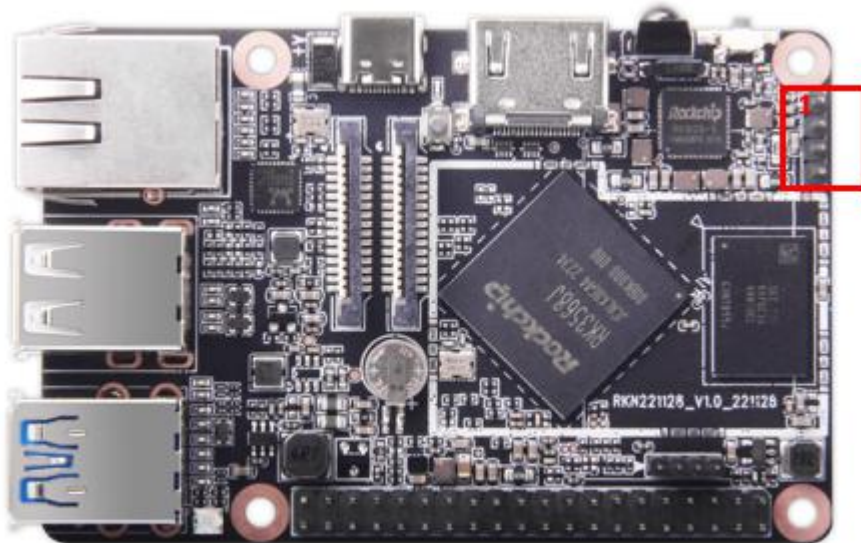

Pin	Definition	Pin	Definition
1	VCC3V3 _ PM	3	UART2_RX_M0_DEBUG
2	UART2_TX_M0_DEBUG	4	GND

6. SUPPORT FORMATS

Audio

- I2S0 with 8 channel
 - Up to 8 channels TX and 8 channels RX path
 - Audio resolution from 16bits to 32bits
 - Sample rate up to 192KHz
 - Provides master and slave work mode, software configurable
 - Support 3 I2S formats (normal, left-justified, right-justified)
 - Only for HDMI inside
- I2S1 with 8 channel
 - Up to 8 channels TX and 8 channels RX path
 - Audio resolution from 16bits to 32bits
 - Sample rate up to 192KHz
 - Provides master and slave work mode, software configurable
 - Support 3 I2S formats (normal, left-justified, right-justified)
 - Support 4 PCM formats (early, late1, late2, late3)

- I2S and PCM mode cannot be used at the same time
- I2S2/I2S3 with 2 channel
 - Up to 2 channels TX and 2 channels RX path
 - Audio resolution from 16bits to 32bits
 - Sample rate up to 192KHz
 - Provides master and slave work mode, software configurable
 - Support 3 I2S formats (normal, left-justified, right-justified)
 - Support 4 PCM formats (early, late1, late2, late3)
 - I2S and PCM mode cannot be used at the same time
- PDM
 - Up to 8 channels
 - Audio resolution from 16bits to 24bits
 - Sample rate up to 192KHz
 - Support PDM master receive mode
- TDM
 - supports up to 8 channels for TX and 8 channels RX path
 - Audio resolution from 16bits to 32bits
 - Sample rate up to 192KHz v Provides master and slave work mode, software configurable
 - Support 3 I2S formats (normal, left-justified, right-justified)
 - Support 4 PCM formats (early, late1, late2, late3)
- Voice Activity Detection(VAD)
 - Support read voice data from I2S/PDM
 - Support voice amplitude detection v Support Multi-Mic array data storing
 - Support a level combined interrupt

Video Codec

- Video Decoder
 - H.265 HEVC/MVC Main10 Profile yuv420@L5.1 up to 4096x2304@60fps
 - H.264 AVC/MVC Main10 Profile yuv400/yuv420/yuv422/@L5.1 up to 4096x2304@60fps
 - VP9 Profile0/2 yuv420@L5.1 up to 4096x2304@60fps
 - VP8 version2, up to 1920x1088@60fps
 - VC1 Simple Profile@low, medium, high levels, Main Profile@low, medium, high levels, Advanced Profile@level0~3, up to 1920x1088@60fps
 - MPEG-4 Simple Profile@L0~6, Advanced Simple Profile@L0~5, up to 1920x1088@60fps
 - MPEG-2 Main Profile, low, medium and high levels, up to 1920x1088@60fps
 - MPEG-1 Main Profile, low, medium and high levels, up to 1920x1088@60fps
 - H.263 Profile0, levels 10-70, up to 720x576@60fps
- Video Encoder
 - H.264/AVC BP/MP/HP@level4.2, up to 1920x1080@60fps
 - H.265/HEVC MP@level4.1, up to 1920x1080@100fps (4096x4096@10fps with TILE)
 - Support YUV/RGB video source with rotation and mirror

JPEG CODEC

- JPEG decoder
 - Decoder size is from 48x48 to 65536x65536
 - Support YUV400/YUV411/YUV420/YUV422/YUV440/YUV444
 - Support 1920x1080@120fps
 - Support MJPEG
- JPEG encoder
 - Baseline Non-progressive
 - up to 8192x8192 v up to 90 million pixels per second

7. PRECAUTIONS FOR USE

1. Relative humidity: 10% ~ 90% .
2. Storage temperature: -10 ~ 125 °C
3. Operation temperature: Industrial version (-40°C ~85 °C) Commercial Version (0°C ~70 °C)
4. Do not squeeze、 distort or disassemble the board.
5. Keep the board away from static electricity.
6. Keep the board away from water and other liquid.
7. Clean the board with soft and clean dry cloth when it's dirty.
8. Don't use long connect wires which may affect performance and image quality.