

深圳金亚太科技有限公司

Shenzhen Geniatech Co.,Ltd.

# SPECIFICATION

MODEL:SOM-3576

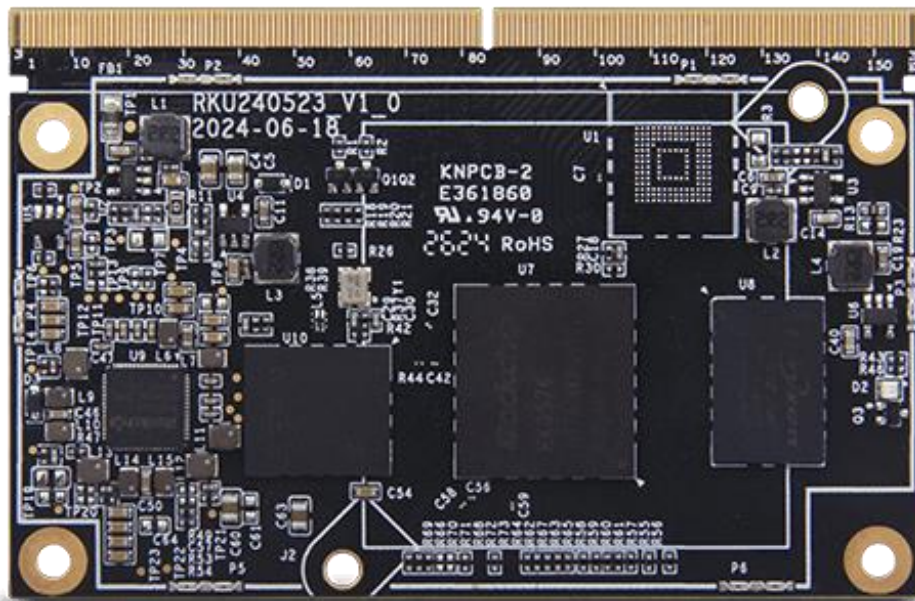

## Confirmation

REVISION HISTORY					
VERSION	DATE	BOARD ID	PAGE	DESCRIPTION	AUTHOR
V1.0	2024/6/26	RKU240523_v1_0		specification	

APPROVED BY GENIATECH		
PREPARED BY 编写	CHECKED BY 审核	APPROVED BY 批准

Please return the original copy after approved by your company with stamp and signature.  
请在贵公司盖章并签字后寄回正本一份。

APPROVED BY CUSTOMER		
COMMENTS 确认意见	APPROVED BY 批准签字	COMPANY STAMP 盖章

Website: [www.geniatech.com](http://www.geniatech.com)

Address: Room 02-04, 10 / F, Block A, Building 8, Shenzhen International Innovation

Valley, Dashi Road, Nanshan District, Shenzhen, Guangdong, China.

## CONTENT

1.GENERAL DESCRIPTION.....	1
2.PRODUCT PICTURES.....	2
3.BOARD VIEW.....	3
4.FEATURES.....	4
5.SUPPORT FORMATS.....	5
6.EXTENSION GPIO DEFINITION.....	5
7. PRECAUTIONS FOR USE .....	10

## 1.GENERAL DESCRIPTION

The SOM-3576 module is designed by Geniatech, based on Rock-chip RK3576, with quad-core Cortex-A72 and quad-core Cortex-A53, build-in NPU 6TOPs for INT8. It supports Bluetooth, Wi-Fi, audio, video, camera and other functions, and has a variety of video input and output interfaces. With the dual-gigabit adaptive RJ45 Ethernet port, it is suitable for intelligent NVR, cloud terminal, Internet of Things gateway, industrial control, information publishing terminal, multimedia advertising machine and other scenarios, and can also be widely used in the field of embedded artificial intelligence. It constitutes a complete AI development board by connecting the core board to the baseboard through the standard SODIMM 314P interface. Below is the detail features:

(I) Standard SODIMM interface ,the size is only 82mm x 53mm.

(II) Quad-core Cortex-A72 and Quad-core Cortex-A53, build-in NPU up to 6TOPs for INT8, Support mainstream deep learning frameworks; It can bring more optimized performance for all kinds of AI application scenarios.

(III) LPDDR up to 16GB ,32-256GB EMMC FLASH. Compatible with UFS Support for 512GB /1TB expansion.

(IV) Integrated PCIe/GMAC/SDIO3.0/USB3.0,With extensible gigabit Ethernet, WiFi6/Bluetooth, so that network communication has a higher rate.

(VI) Support 4K@60fps H.264/AVC video decoding and 8K@30fps H.265/H.264 /VP9 video coding.

(VII) Supports Android14&Debian12 multiple operating systems, the performance is stable and reliable.

(VIII) With immersion gold process pin, corrosion resistant, 2 studs fixed, It can operate stably at 0°C -60°C working temperature for 7X24 hours.

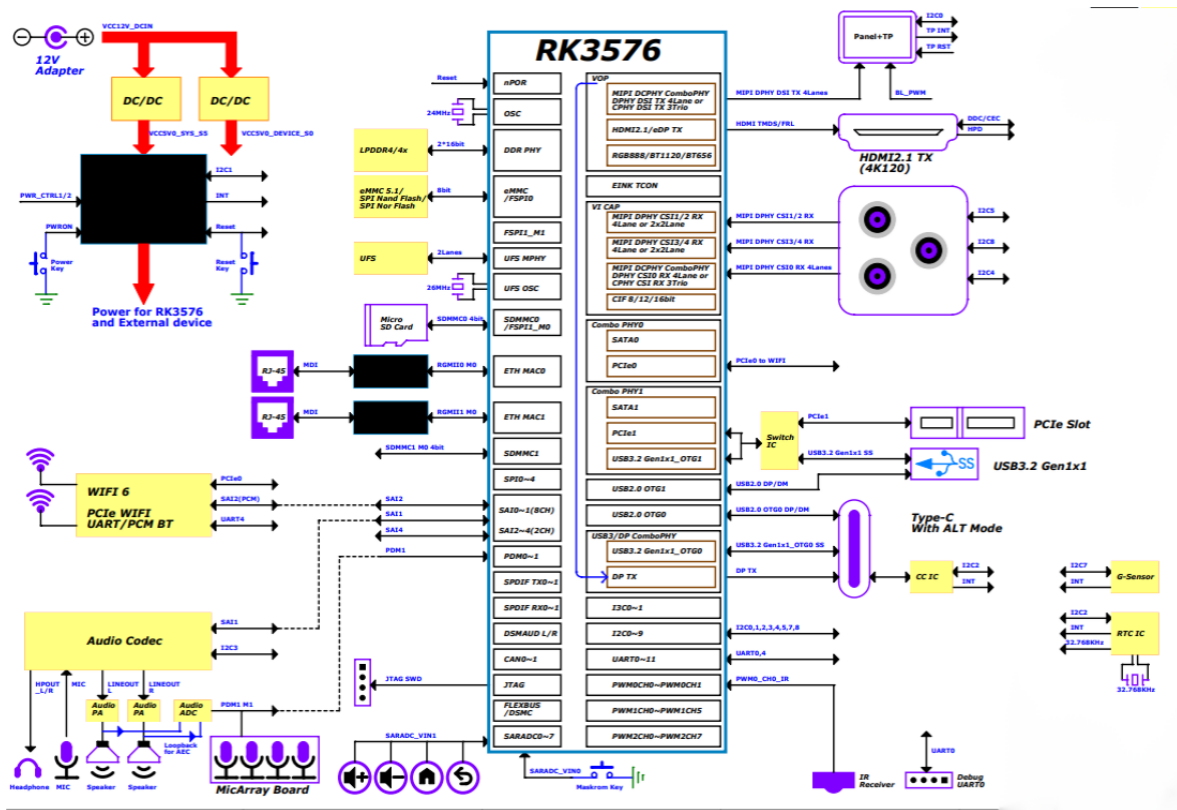

## 2.PRODUCT PICTURES

Below pictures are for reference only:

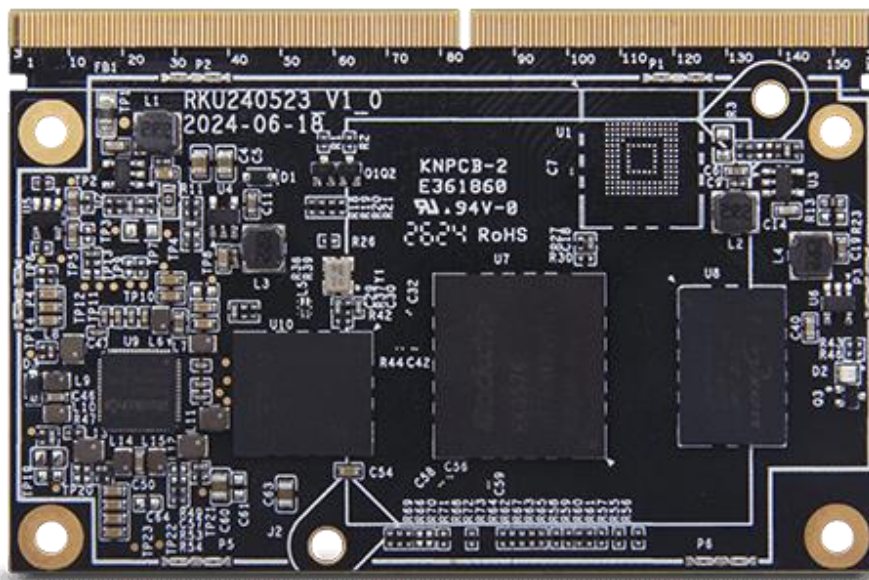

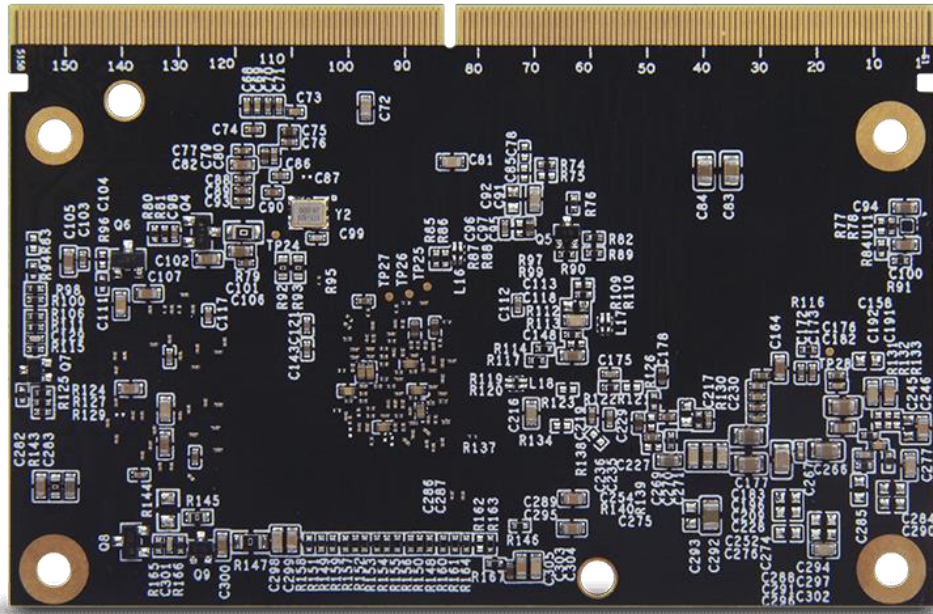

### 3.BOARD VIEW

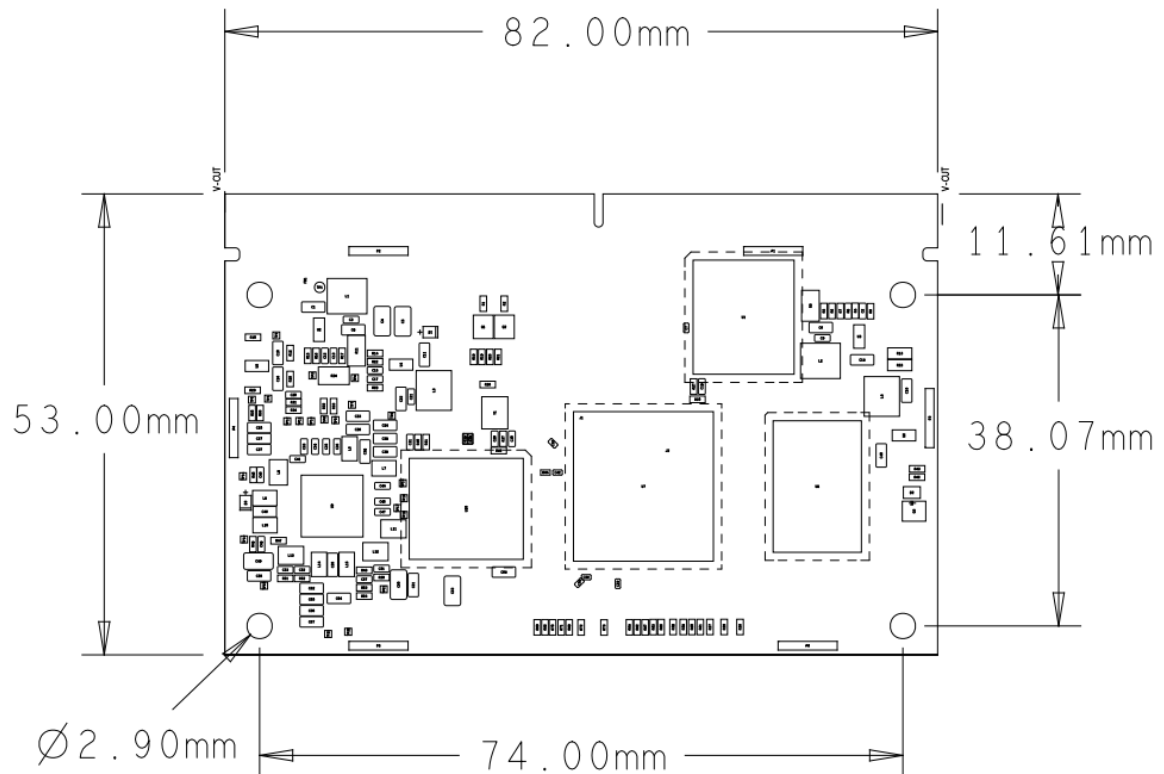



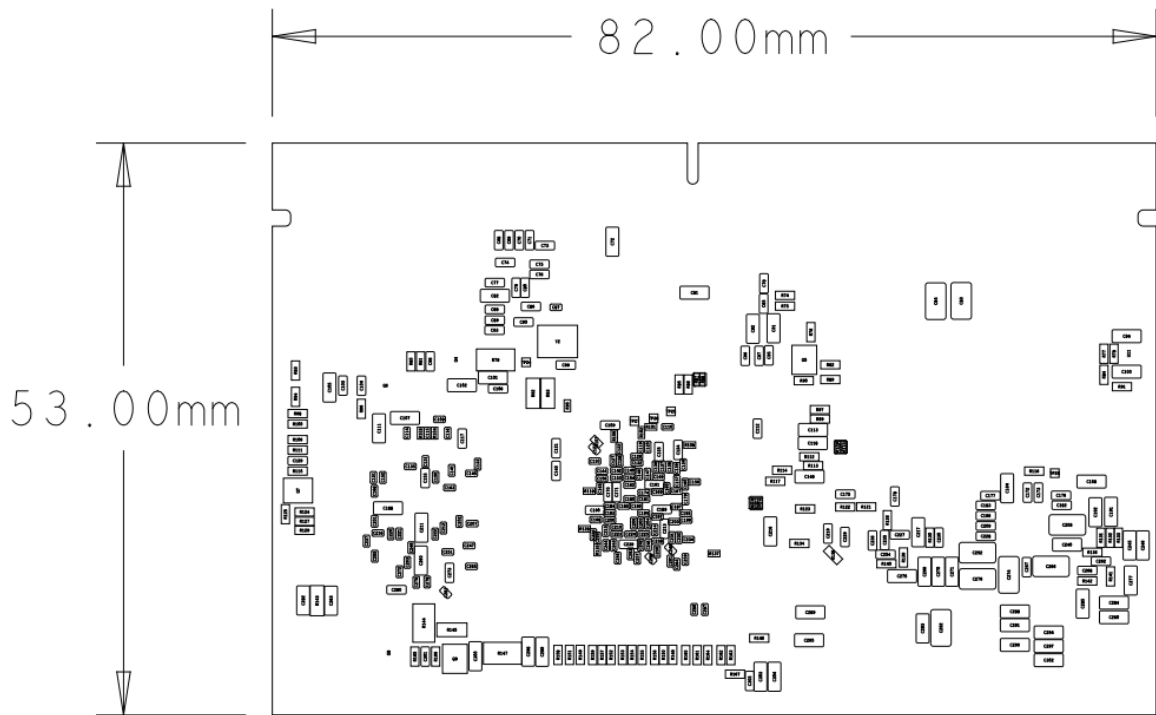

## 4.FEATURES

Chipset	Rockchip 3576	
Market area	Global	
OSD Language	English/Chinese(multi language OSD)	
Processor	OS	Android14 / Debian12
	CPU	Quad-core Cortex-A72and Quad-core Cortex-A53
	GPU	Mali-G52 MC3
	RAM	4GB(8/16Optional)
	EMMC FLASH	32GB (64G/128G/256G Optional)
SODIMM Interfaces	Ethernet	2 x GIGABIT Ethernet
	PCIe	PCIe3.0 3×PCIe2.0(1 lanes)
	USB	USB3.0*1、
	MIPI CSI	*2
	MIPI DSI	*1
	I2S	*2

	HDMI	HDMI OUT*1( 7680x4320@60Hz)
	SDIO	*12
	eDP	*1
	Type-c	*1
	SATA	*2
	SPDIF	*1
	SPI	*3
	ADC	*6
	DEBUG	*1
	I2C	*4
	POWER	5V/3A
Dimensions	82 x 53 mm	

## 5.SUPPORT FORMATS

### Video Decoder

- Supports video decoder of H.264, H.265, VP9, AV1 and AVS2
- MMU Embedded
- Supports multi-stream decoding in parallel
- H.264 AVC/ Main10 L5.2 : up to 4K@30fps (3840 x2160)
- VP9 Profile0/2 L6.0 : up to 8K@30fps (7680x4320)
- H.265/HEVC Main10 L6.0 : up to 8K@30fps (7680x4320)
- AVS2 Profile0/2 L8.2.120 : up to 8K@30fps (7680x4320)
- AV1 Main 10 L6.0 : up to 8K@30fps (7680x4320)

### Video Encoder

- Real-time H.265/H.264 video encoding
- Support up to 4K@60fps
- Multi-channel encoder in parallel for less resolution

## 6. EXTENSION GPIO DEFINITION



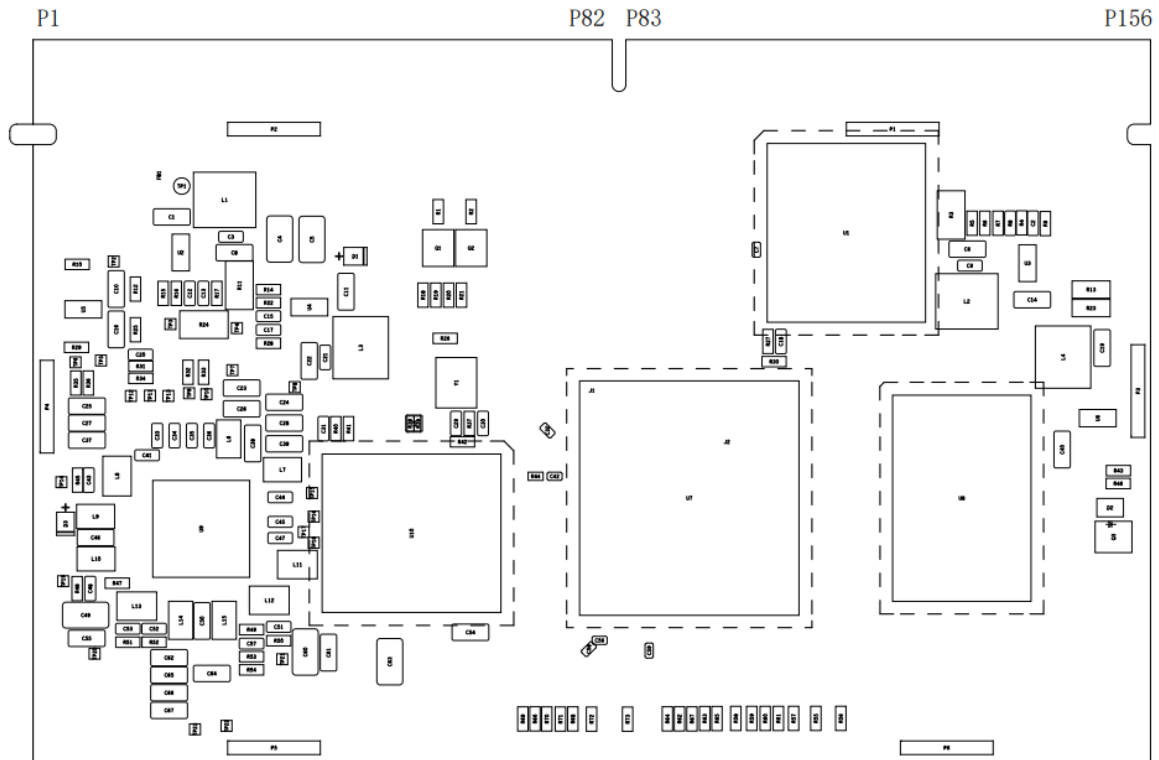

## Front view

No.	Functional Description	No.	Functional Description	No.	Functional Description
P1	VCCIN	P53	WIFI_PCIE0_REFCLKP	P105	USB3_OTG0_SSRX2P/DP_TX_D2P
P2	VCCIN	P54	WIFI_PCIE0_TXN	P106	USB3_OTG0_SSRX2N/DP_TX_D2N
P3	VCCIN	P55	WIFI_PCIE0_TXP	P107	USB3_OTG0_SSTX1N/DP_TX_D1N
P4	VCCIN	P56	WIFI_PCIE0_RXN	P108	USB3_OTG0_SSTX1P/DP_TX_D1P
P5	GND	P57	WIFI_PCIE0_RXP	P109	USB3_OTG0_SSRX1P/DP_TX_D0P
P6	GND	P58	GND	P110	USB3_OTG0_SSRX1N/DP_TX_D0N
P7	GND	P59	UART4_RTSN_M1	P111	GND
P8	GND	P60	UART4_CTSN_M1	P112	NA
P9	VCC_3V3_S0	P61	SDMMC1_CMD_M0	P113	NA
P10	VCC_3V3_S0	P62	SDMMC1_D3_M0	P114	NA
P11	VCC_1V8_S0	P63	SAI2_SCLK_M0_CON	P115	NA
P12	VCC_1V8_S0	P64	MIPI_DPHY_CSI0_PDN_H	P116	USB3_HOST1_SSTXN
P13	PWRON_L	P65	SAI2_LRCK_M0_CON	P117	USB3_HOST1_SSTXP

P14	VDC_EXT	P66	SDMMC1_CLK_M0	P118	USB3_HOST1_SSRXP
P15	PMIC_EXT_EN_OUT	P67	SAI2_SDO_M0_CON	P119	USB3_HOST1_SSRXN
P16	VCCA_RK806	P68	GND	P120	GND
P17	LCD_PWREN_H	P69	MIPI_DPHY_CSI1_RX_D0N	P121	NA
P18	I2C3_SCL_M0_Audio	P70	MIPI_DPHY_CSI1_RX_D0P	P122	NA
P19	I2C3_SDA_M0_Audio	P71	MIPI_DPHY_CSI1_RX_D1N	P123	NA
P20	I2C8_SCL_M3	P72	MIPI_DPHY_CSI1_RX_D1P	P124	NA
P21	I2C8_SDA_M3	P73	MIPI_DPHY_CSI1_RX_CLKN	P125	NA
P22	GND	P74	MIPI_DPHY_CSI1_RX_CLKP	P126	NA
P23	NA	P75	MIPI_DPHY_CSI1_RX_D2N/ MIPI_DPHY_CSI2_RX_D0N	P127	NA
P24	NA	P76	MIPI_DPHY_CSI1_RX_D2P/ MIPI_DPHY_CSI2_RX_D0P	P128	NA
P25	NA	P77	MIPI_DPHY_CSI1_RX_D3N/ MIPI_DPHY_CSI2_RX_D1N	P129	NA
P26	NA	P78	MIPI_DPHY_CSI1_RX_D3P/ MIPI_DPHY_CSI2_RX_D1P	P130	NA
P27	NA	P79	MIPI_DPHY_CSI2_RX_CLKN	P131	GND
P28	NA	P80	MIPI_DPHY_CSI2_RX_CLKP	P132	HDMI_TX_D2P
P29	NA	P81	NA	P133	HDMI_TX_D2N
P30	NA	P82	NA	P134	HDMI_TX_D1P
P31	NA	P83	NA	P135	HDMI_TX_D1N
P32	NA	P84	NA	P136	HDMI_TX_D0P
P33	NA	P85	NA	P137	HDMI_TX_D0N
P34	NA	P86	NA	P138	HDMI_TX_D3P
P35	NA	P87	NA	P139	HDMI_TX_D3N
P36	NA	P88	NA	P140	HDMI_TX_SBDP
P37	NA	P89	NA	P141	HDMI_TX_SBDN
P38	NA	P90	NA	P142	GND
P39	NA	P91	GND	P143	SDMMC0_D2
P40	NA	P92	MIPI_DPHY1_DSI_TX_D3N	P144	SDMMC0_D3
P41	NA	P93	MIPI_DPHY1_DSI_TX_D3P	P145	SDMMC0_CMD
P42	NA	P94	MIPI_DPHY1_DSI_TX_D2N	P146	SD_CLK
P43	NA	P95	MIPI_DPHY_DSI_TX_D2P	P147	SDMMC0_D0
P44	GND	P96	MIPI_DPHY_DSI_TX_CLKN	P148	SDMMC0_D1
P45	NA	P97	MIPI_DPHY_DSI_TX_CLKP	P149	GND
P46	NA	P98	MIPI_DPHY_DSI_TX_D1N	P150	NA
P47	NA	P99	MIPI_DPHY_DSI_TX_D1P	P151	DP1_HPDIN_M0
P48	NA	P100	MIPI_DPHY_DSI_TX_D0N	P152	I2C4_SCL_M1_SENSOR
P49	NA	P101	MIPI_DPHY_DSI_TX_D0P	P153	PCIE_PWREN_H
P50	NA	P102	GND	P154	I2C4_SDA_M1_SENSOR

P51	GND	P103	USB3_OTG0_SSTX2N/DP_T X_D3N	P155	UART9_RX_M0_BT
P52	WIFI_PCIE0_REFCLKN	P104	USB3_OTG0_SSTX2P/DP_T X_D3P	P156	GND

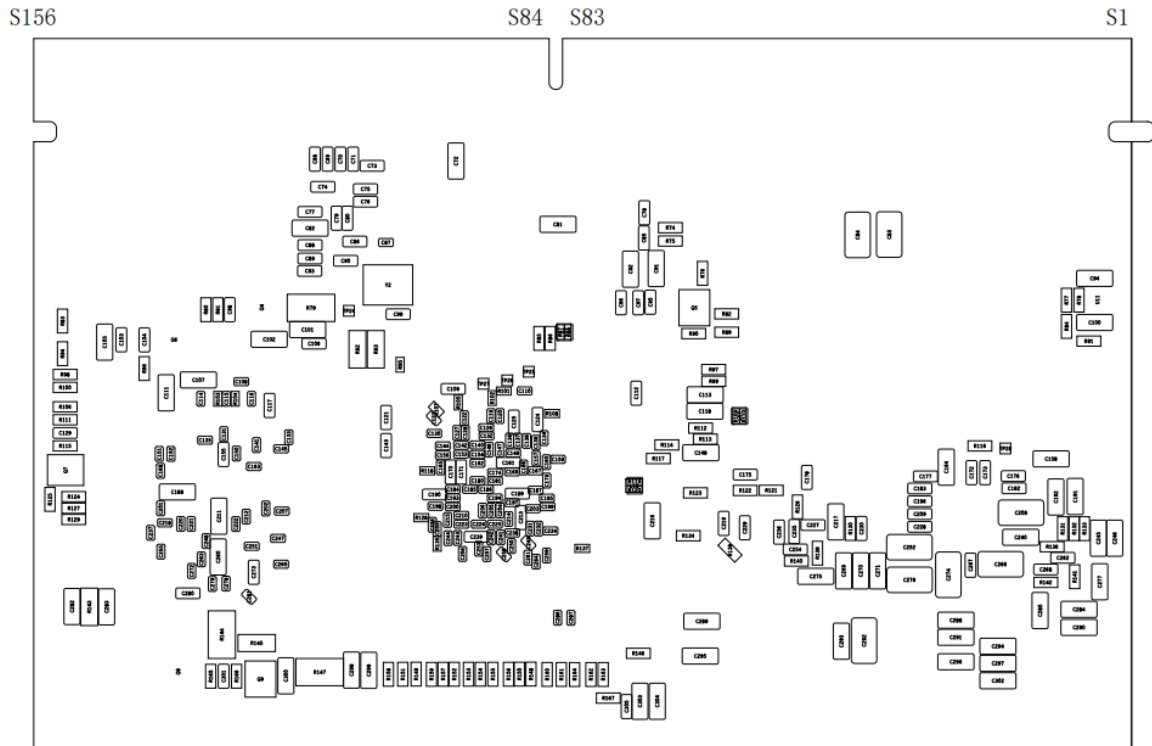

### Back view

No.	Functional Description	No.	Functional Description	No.	Functional Description
S1	VCCIN	S53	GND	S105	SARADC_VIN4
S2	VCCIN	S54	RTC_INT_L	S106	SARADC_VIN3_HP_HO OK
S3	VCCIN	S55	UART2_TX_M0_DEBU G	S107	SARADC_VIN2_HW_ID
S4	VCCIN	S56	UART2_RX_M0_DEBU G	S108	SARADC_VIN0_BOOT
S5	GND	S57	HP_CTL_H	S109	SARADC_VIN1_KEY/R ECOVERY
S6	GND	S58	LCD_BL_PWM1_CH1_ M0	S110	USB2_OTG0_VBUSDE T
S7	GND	S59	I2C2_SDA_M0_CC_RT C	S111	USB2_OTG0_ID

S8	GND	S60	I2C2_SCL_M0_CC_RT C	S112	USB2_OTG1_ID
S9	VCC_1V8_S3	S61	GND	S113	USB2_OTG1_VBUSDE T
S10	VCC_1V8_S3	S62	SDMMC1_D0_M0	S114	DP_TX_AUXN
S11	RESET_L	S63	SDMMC1_D1_M0	S115	DP_TX_AUXP
S12	MIPI_CAM1_PWREN_H	S64	LCD_BL_EN_H	S116	GND
S13	HDMIIRX_DET_L	S65	UART4_TX_M1	S117	USB2_OTG0_DM
S14	WIFI_WAKE_HOST_H	S66	SDMMC1_D2_M0	S118	USB2_OTG0_DP
S15	HOST_WAKE_HOST_H	S67	MIPI_DPHY_CSI1_PDN _H	S119	NA
S16	BT_WAKE_HOST_H	S68	GMAC1_MDIO_M0	S120	NA
S17	BT_REG_ON_H	S69	GMAC1_MDC_M0	S121	USB2_HOST1_DP
S18	I2C9_SDA_M3	S70	GMAC1_RSTn	S122	USB2_HOST1_DM
S19	I2C9_SCL_M3	S71	SAI2_SDI_M0_CON	S123	NA
S20	WIFI_REG_ON_H	S72	GMAC1_MCLKINOUT_ M0	S124	NA
S21	USBCC_INT_L	S73	GMAC1_TXD3_M0	S125	NA
S22	I2C5_SDA_M3_MIPI_CSI 1	S74	GMAC1_TXD2_M0	S126	NA
S23	I2C5_SCL_M3_MIPI_CSI 1	S75	GMAC1_TXCTL_M0	S127	GND
S24	HDMI_TX_HPDI_M1	S76	GMAC1_TXD1_M0	S128	NA
S25	GSENSOR_INT_L	S77	GMAC1_TXCLK_M0	S129	NA
S26	UART1_TX_M2	S78	GMAC1_RXD0_M0	S130	NA
S27	LCD_RESET_L	S79	GMAC1_TXD0_M0	S131	NA
S28	UART10_RX_M0	S80	GMAC1_RXCLK_M0	S132	NA
S29	SARADC_VIN7_LCD_ID	S81	GMAC1_RXD1_M0	S133	NA
S30	USB_OTG0_PWREN_H	S82	GMAC1_RXCTL_M0	S134	NA
S31	NA	S83	GMAC1_RXD2_M0	S135	NA
S32	UART10_TX_M0	S84	GMAC1_RXD3_M0	S136	GND
S33	SPK_CTL_H	S85	ETH_CLK1_25M_OUT_ M0	S137	MIPI_DPHY_CSI0_CAM _CLKOUT
S34	UART1_RX_M2	S86	GND	S138	MIPI_DPHY_CSI1_CAM _CLKOUT
S35	PDM1_SDI3_M1	S87	SPI4_MISO_M0	S139	MIPI_DPHY_CSI0_PWR EN_H
S36	HDMI_TX_ON_H	S88	SPI4_CLK_M0	S140	MIPI_DPHY_CSI3_CAM _CLKOUT
S37	NA	S89	SPI4_MOSI_M0	S141	SDMMC0_DET_L
S38	PDM1_SDI1_M1	S90	UART7_TX_M0	S142	TP_RST_L

S39	PDM1_CLK0_M1	S91	UART7_RX_M0	S143	TP_INT_L
S40	SAI1_LRCK_M0	S92	TYPEC_DPTX_AUX_P UPDCTL2	S144	NA
S41	SAI1_SDI0_M0	S93	TYPEC_DPTX_AUX_P UPDCTL1	S145	NA
S42	PDM1_CLK1_M1	S94	SDMMC0_PWREN_H	S146	NA
S43	SAI1_SCLK_M0	S95	NA	S147	NA
S44	SAI1_SDO0_M0	S96	NA	S148	NA
S45	SAI1_MCLK_M0	S97	SPI4_CSN0_M0	S149	NA
S46	GND	S98	NA	S150	HDMI_TX_CEC_M0
S47	NA	S99	NA	S151	HDMI_TX_SDA
S48	NA	S100	USB3_HOST_PWREN_ H	S152	HDMI_TX_SCL
S49	NA	S101	NA	S153	MIPI_TE_M1_GPIO3_A 2
S50	NA	S102	I2C7_SCL_M1_Sensor	S154	NA
S51	NA	S103	I2C7_SDA_M1_Sensor	S155	SARADC_VIN7_LCD_ID
S52	NA	S104	SARADC_VIN6	S156	NA
				S157	NA
				S158	NA

## 7.PRECAUTIONS FOR USE

1. Relative humidity: 10% ~ 90% .
2. Storage temperature: -20 ~ 85℃
3. Operation temperature: 0 ~ 60℃
4. Do not squeeze、 distort or disassemble the board.
5. Keep the board away from static electricity .
6. Keep the board away from water and other liquid.
7. Clean the board with soft and clean dry cloth when it's dirty.
8. Don't use long connect wires which may affect performance and image quality.